

GRV Circular Formwork

Anchorless Circular Formwork with GRV Articulated Walers



Edition 11 | 2012

PERI GmbH
Formwork Scaffolding Engineering

Rudolf-Diesel-Strasse 19
89264 Weissenhorn
Germany
Tel. +49 (0) 7309.950-0
Fax +49 (0) 7309.951-0
info@peri.com
www.peri.com

Important Notes:

Without exception, all current safety regulations must be observed in those countries where our products are used.

The photos shown in this brochure feature construction sites in progress. For this reason especially safety and anchor details cannot always be considered as conclusive or final. These are subject to the risk assessment carried out by the contractor.

The systems or items shown are not necessarily available in all countries.

Safety instructions and load specifications are to be strictly observed at all times. Separate structural calculations are required for any deviations from the standard design data.

The information contained herein is subject to technical changes in the interests of progress. Errors and typographical mistakes reserved.

Content

GRV Articulated Waler Circular Formwork

- 2 GRV Circular Formwork:
for circular structures without ties
- 4 Cost-effective customized solutions
Arched bridges with GRV
- 6 The GSRV Articulated Spindle Waler
Continuously adjustable to suit any radius
- 8 The PERI assembly service
Efficient and cost-effective pre-assembly
- 10 Example of use
- 12 Planing aid for circular containers
- 14 Components

GRV Articulated Waler Circular Formwork

For circular structures without ties



Complete circular tank shuttered with GRV without using any ties.

The GRV circular formwork is used for the realisation of circular structures without the use of ties. The external ring tension force as well as the internal compression force are transferred by the closed ring of walers. In this way, significant savings can be achieved as the required alternative solution of watertight tie points is particularly complicated and therefore very expensive.

The GRV articulated waler circular formwork can be used for all radii. By means of the patented articulated connections of the GRV walers, even small radii of 0.60 m can be shuttered.

The main area of application for the GRV circular wall formwork is the construction of circular industrial containers. GRV formwork also offers particularly cost-effective solutions for the construction of arched bridges. The system can be used for a wide range of arched forms – for example, circular, segmental, or basket arches.

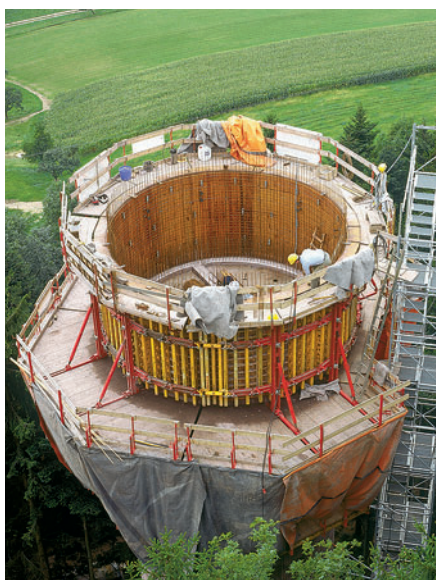

Circular formwork with GRV on PERI KGF 240 climbing scaffold.



GRV in use as tapering circular column formwork.

Cost-effective customized solutions

Arched bridges with GRV

Regardless whether it is for circular, segmental, basket or other arches – the GRV circular formwork is always a particularly economical solution.

In combination with proven GT 24 lattice girders, spindles and push-pull props, virtually all arched bridges can be shuttered almost entirely with system components. The size of the arch makes no difference as the articulated connections of the walers have an extensive adjustment range.

Ground plan

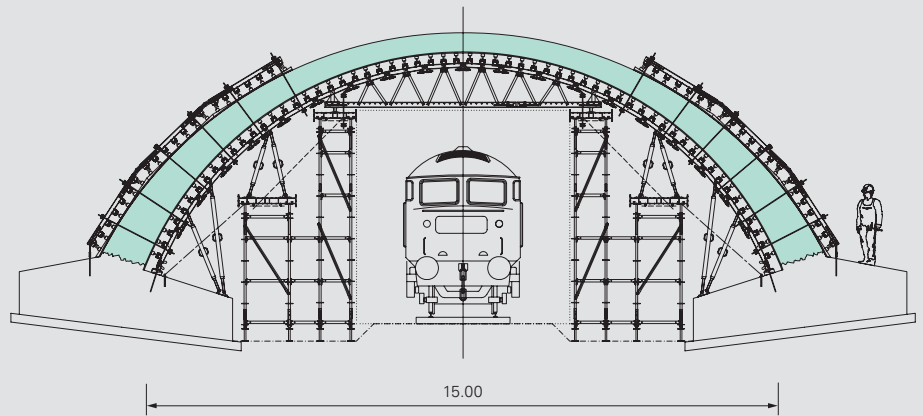

Detailed overview of the bearing section

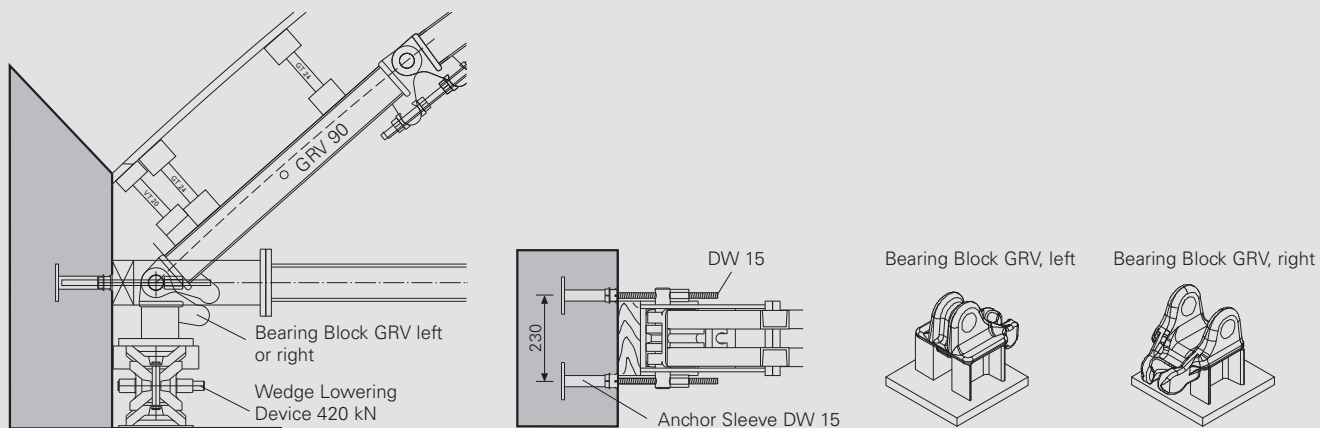

GRV circular formwork and steel walers as self-supporting shoring for arched bridges.

The GSRV Articulated Spindle Waler

Continuously adjustable to suit any radius

For the GRV circular formwork there are four different patented articulated walers which allow the realisation of the smallest pitch circle radius – a minimum of 0.90 m for the articulated waler with a length of 300 mm.

GRV 90

r min = 1.80 m
(approx. 2.10 m concrete radius*)

GRV 75

r min = 1.50 m
(approx. 1.80 m concrete radius*)

GRV 60

r min = 1.20 m
(approx. 1.50 m concrete radius*)

GRV 30

r min = 0.60 m (
approx. 0.90 m concrete radius*)

*with standard formwork assembly

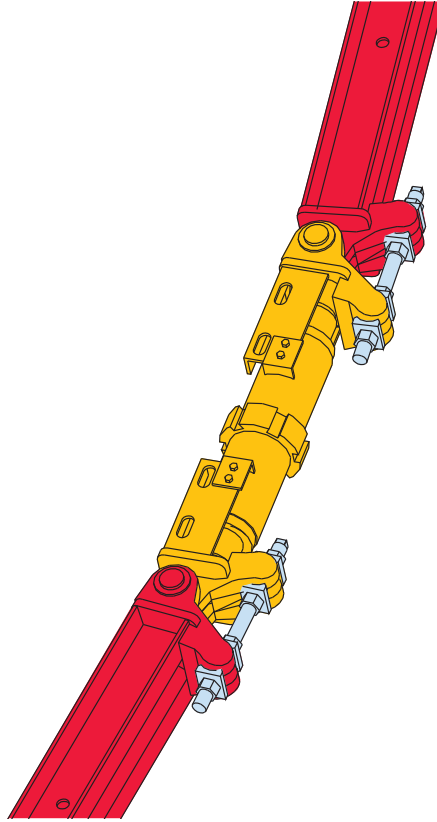

Adjusting the Articulated Spindle Waler GSRV with the Hook Spanner.

The GRV circular formwork can also be used for larger radii. It is especially cost-effective when several identical circular structures are to be concreted one after the other.



Adjustability of the GRV articulated connections

The Adjusting Bolt STS 360 is used for all Articulated Waler GRV 75, 60 and 30 connections as well as with the Articulated Spindle Waler GSRV 60 – 90.

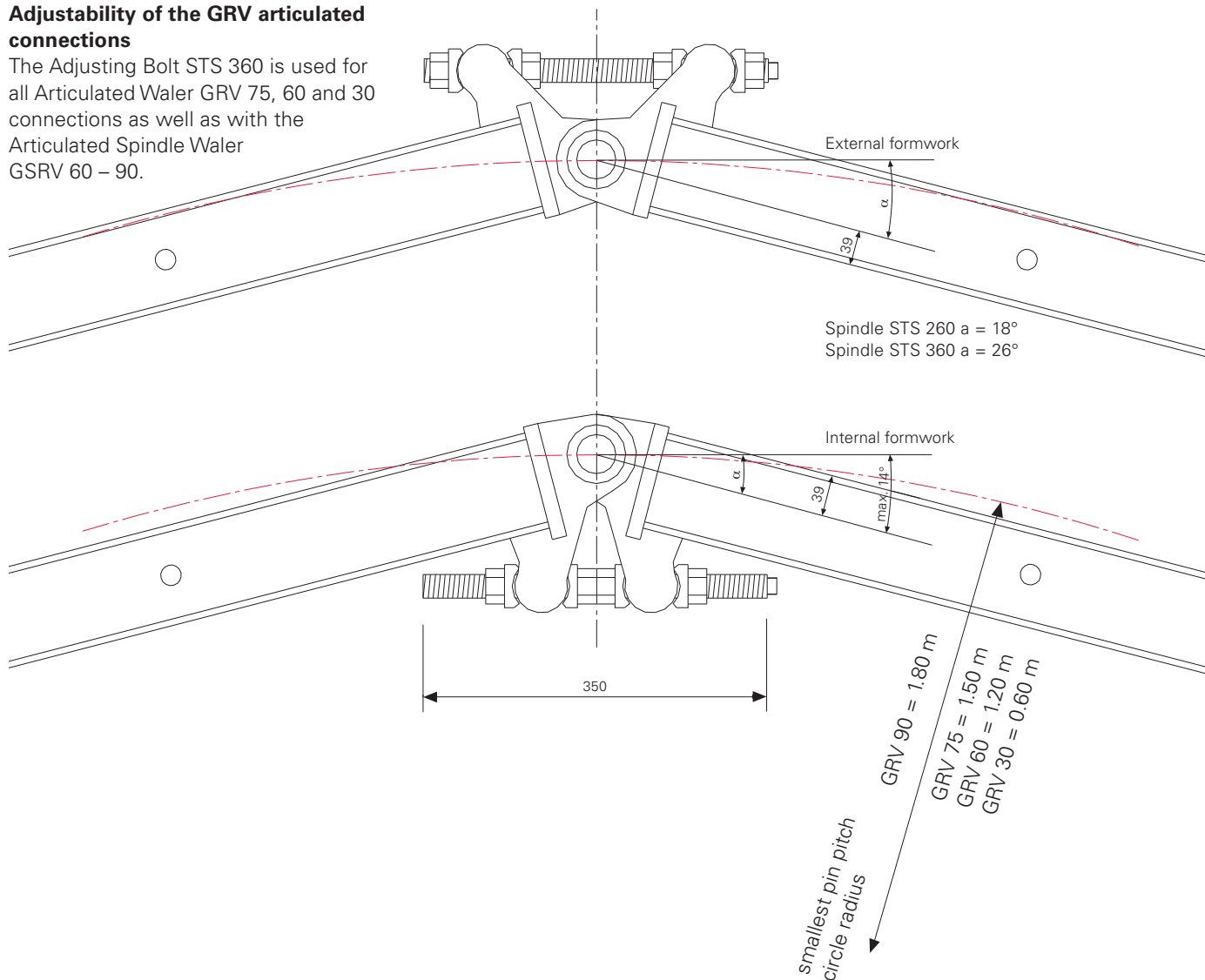

GRV: smallest pin pitch radii [m]				
	inside		outside	
	Nut M24 DIN EN ISO 4032 Item no. 022250	Nut M24 DIN EN ISO4035	Nut M24 DIN EN ISO 4032 Item no. 022250	Adjusting Bolt
GRV 90	2.20	1.72	1.58	STS 360
GRV 75	1.85	1.44	1.35	STS 360
GRV 60	1.35	1.10	0.91	STS 360
GRV 30	1.30 – 1.15			STS 260
GRV 30	0.75	0.60	STS 260, shortened	

For an inner circle, a minimum of 13 GRV walers has to be used otherwise the angle α would be less than 14°.

The PERI assembly service

Efficient and cost-effective pre-assembly

Even if the basic assembly of the GRV formwork elements is usually carried out on the construction site, prefabrication by the PERI assembly service team is still an economical alternative.

One of our wide range of services is the preparation of complete formwork elements in our plant – tailored to match the requirements of the structure as well as the individual construction planning. Our specialists have the required space at their disposal along with the necessary machines and equipment as well as extensive experience in formwork assembly. This results in ready-to-use formwork elements – precision-

made and delivered just-in-time to the site. There are numerous advantages for the contractor: no production facilities or assembly areas and machines are necessary, and no personnel have to be assigned for these activities on the construction site. One very important aspect is also quality assurance as the need to “improvise” due to lack of equipment and missing materials is avoided.

Assembly of GRV panels with segment boards.

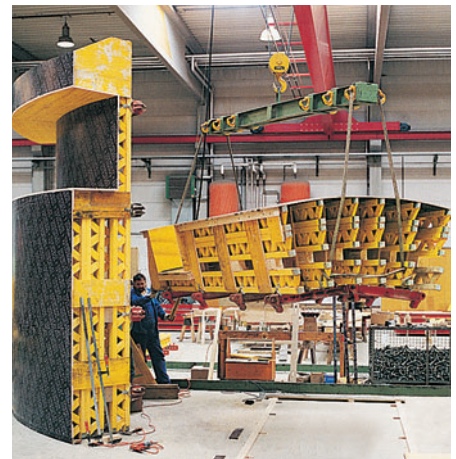

Even complicated cross sections for sewage treatment plants are no problem with PERI GRV.



The GRV articulated waler is continuously adjustable and thus allows the realisation of virtually all circular structures.

Note:

Pre-assembled GRV panels must not exceed the permissible transportation width.



Mark out the required pin pitch circle radius on a template and drill four holes each with \varnothing of 40 mm using the appropriate spacing for the size of articulated waler selected (900 mm, 750 mm, 600 mm or 300 mm) centrally on the circular arc. (Fig. 1)

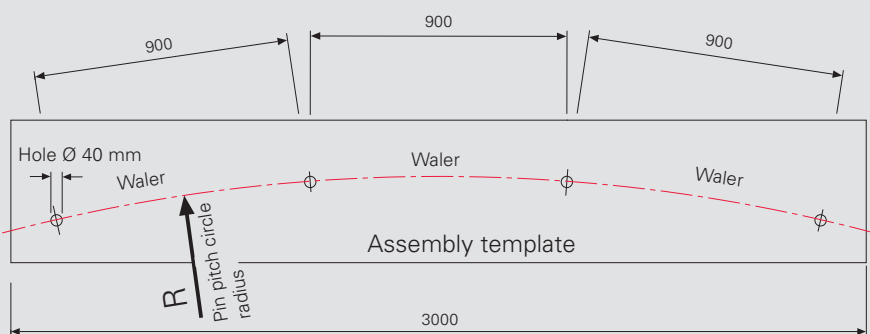

Fig. 1

Lay the three articulated walers on the template and connect with two pins. The two outside walers are only roughly aligned with the drilled hole. (Fig. 2)

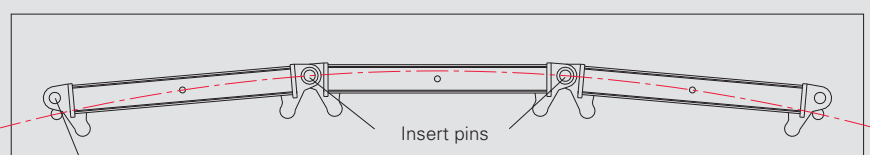

Fig. 2

Insert adjusting bolts with M24 nuts loosely fitted, then tighten the two nuts on the inside waler. Now use the two remaining nuts to line up the outside walers with the drilled holes (visual check). (Fig. 3)

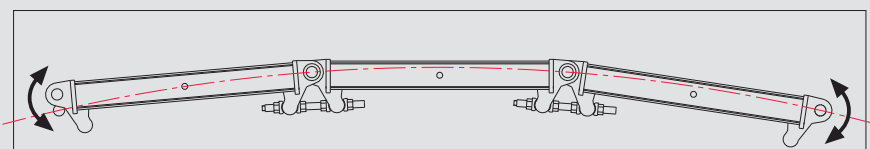

Fig. 3

This procedure eliminates the clearance of the waler pins, with the inside formwork in compression and the outside formwork in tension. The girders can now be fitted as required.

GRV Circular Formwork

Example of use

Circular tank with haunch

Inside radius: 6.00 m
Wall thickness: 0.30 m
Concreting height: 5.00 m

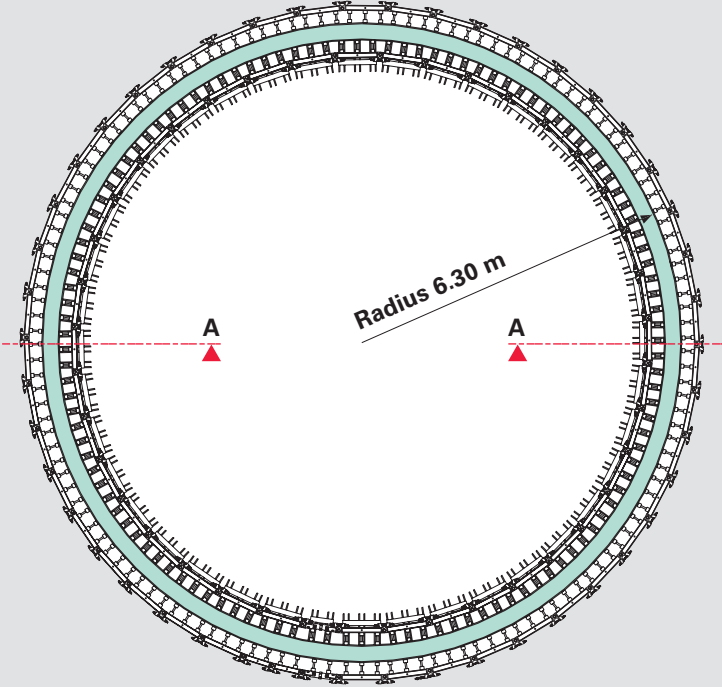

Panel assembly

Inside panel

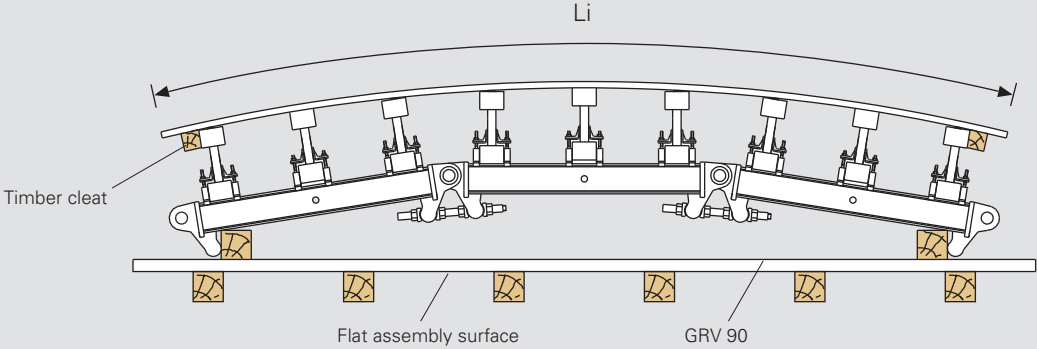

Outside panel

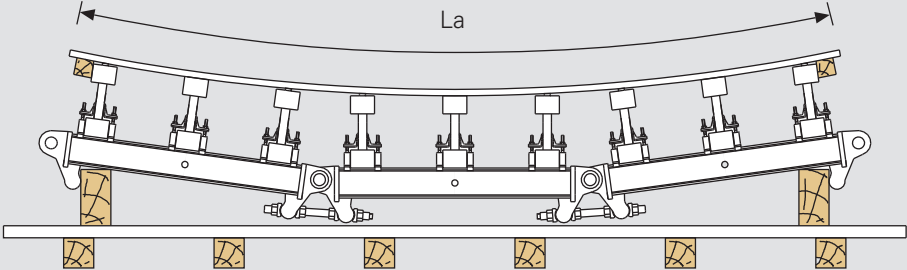

The formlining joint of the panel is aligned radially with the centre line of the pin between the girders.

Section A-A

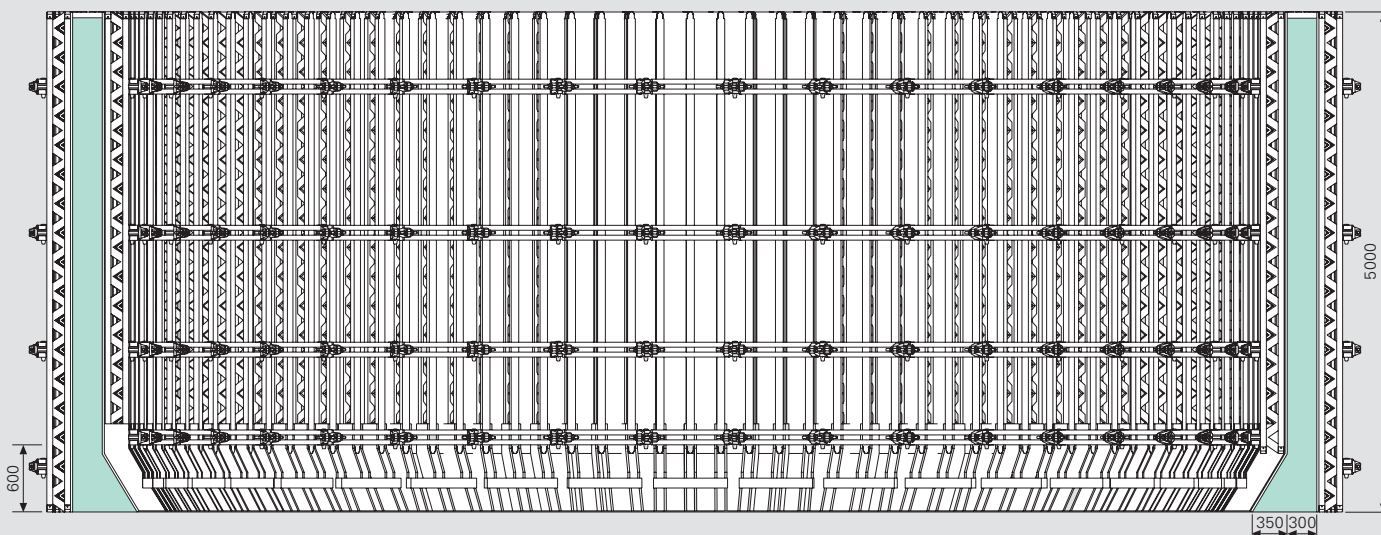

Formlining joint variations

1. Formlining joint between the girders

With TRIO Alignment Coupler BFD and filler support.

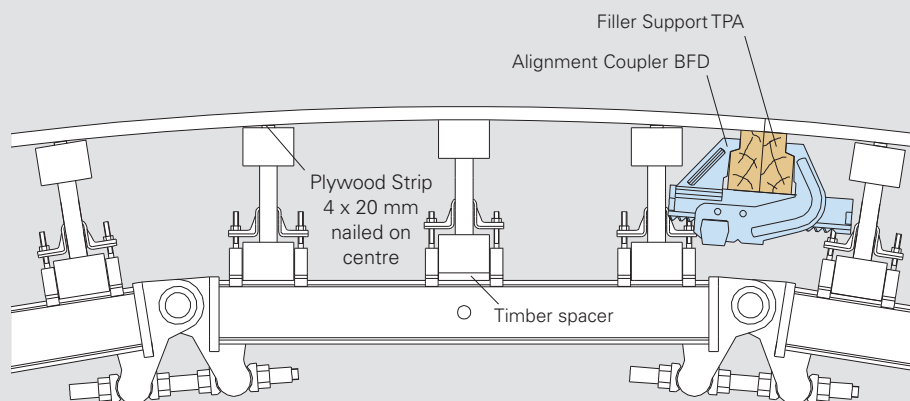

2. Formlining joint on the girders

With a clamping device and the Anchor Sleeve DW 15, Item no. 026280.

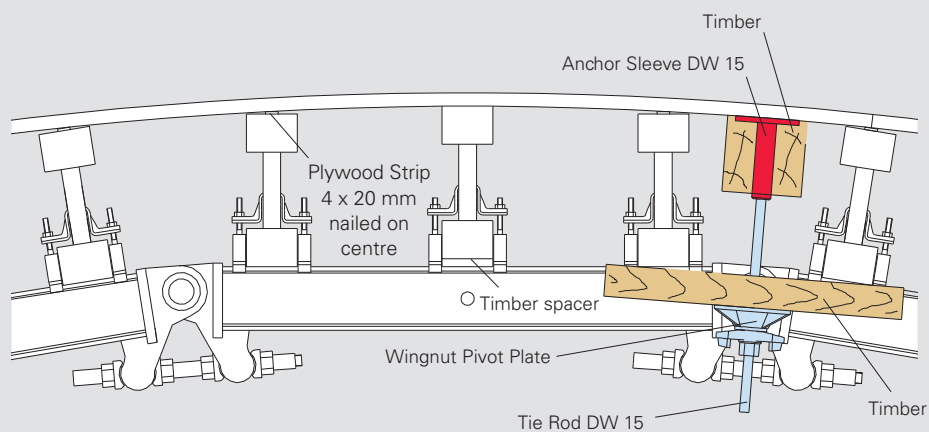

GRV Circular Formwork

Planing aid for circular containers

This table serves to determine the pin pitch circle radius and number of articulated walers required. The exact values can be determined on a full-scale plan or by means of CAD.

1. Determination of pin pitch circle radius R		inside	outside		
Inside concrete radius Ri	[m]		Outside concrete radius Ra	[m]	
Formlining thickness	[m] -		Formlining thickness	[m] +	
Open formwork	[m] -		Open formwork	[m] +	
PERI girder	[m] -	0, 2 4 0	PERI girder	[m] +	
Packing timber as required	[m] -		Packing timber as required	[m] +	
up to pin centre line	[m] -	0, 0 3 9	up to pin centre line	[m] +	
0	,		0	,	
2	,		2	,	
4	,		4	,	
0			0		
0	,		0	,	
0	,		0	,	
3	,		3	,	
9			9		
Inside pin pitch circle radius	[m]	_____	Outside pin pitch circle radius	[m]	_____
2. Number of articulated walers N		inside	outside		
No. of GRVs Ni =	pin pitch circle radius x	6.988 GRV 90 = _____	No. of GRVs Na =	pin pitch circle radius x	6.974 GRV 90 = _____
		8.385 GRV 75 = _____			8.369 GRV 75 = _____
		10.482 GRV 60 = _____			10.462 GRV 60 = _____
GRV 75, 60, 30 as well as Articulated Spindle Waler GSRV 65 – 90 are used to close the circumference.					
Total requirements	GRV 90	GRV 75	GRV 60	Spindle Waler	Recommendation: Spindle Waler per ring
_____ Inside rings x Ni Pieces					up to Ø 10 m 1 piece
_____ Outside rings x Na Pieces					up to Ø 20 m 2 pieces
Total Pieces					up to Ø 30 m 3 pieces
3. Number of girders N		inside	outside		
Ni x 3 or 2 =	_____ Pieces _____ Length		Na x 3 or 2 =	_____ Pieces _____ Length	
Check this quantity against the number of walers / ring actually chosen					
4. Determine length of formlining L		inside	outside		
Internal circumference	$U_i = 2 \times r_i \times \pi$	= _____ [m]	External circumference	$U_a = 2 \times r_a \times \pi$	= _____ [m]
Li/waler section	$= \frac{U_i}{N_i}$	= _____ [m]	La/waler section	$= \frac{U_a}{N_a}$	= _____ [m]
Li/panel width for	_____ Waler	= _____ [m]	La/panel width for	_____ Waler	= _____ [m]

With a closed formwork ring, the GRV circular formwork accommodates a maximum compression or tension force of 300 kN.

Example:

Radius $r = 11 \text{ m}$
 Fresh concrete pressure $P_b = 30 \text{ kN/m}^2$
 Loading height $h = 90 \text{ cm}$

The external ring tension force (Z_{Ring}), is critical as the inner compression force (D_{Ring}) is always smaller.

For calculating the actual water tension force:

$$Z_{\text{Ring}} = r \times P_b \times h$$

$$Z_{\text{Ring}} = 11 \text{ m} \times 30 \text{ kN/m}^2 \times 0.90 \text{ m}$$

$$Z_{\text{Ring}} = 297 \text{ kN} < 300 \text{ kN permissible}$$

where:

- r = outside radius [m]
- P_b = fresh concrete pressure [kN/m²]
- h = height of load carried by the waler [m]

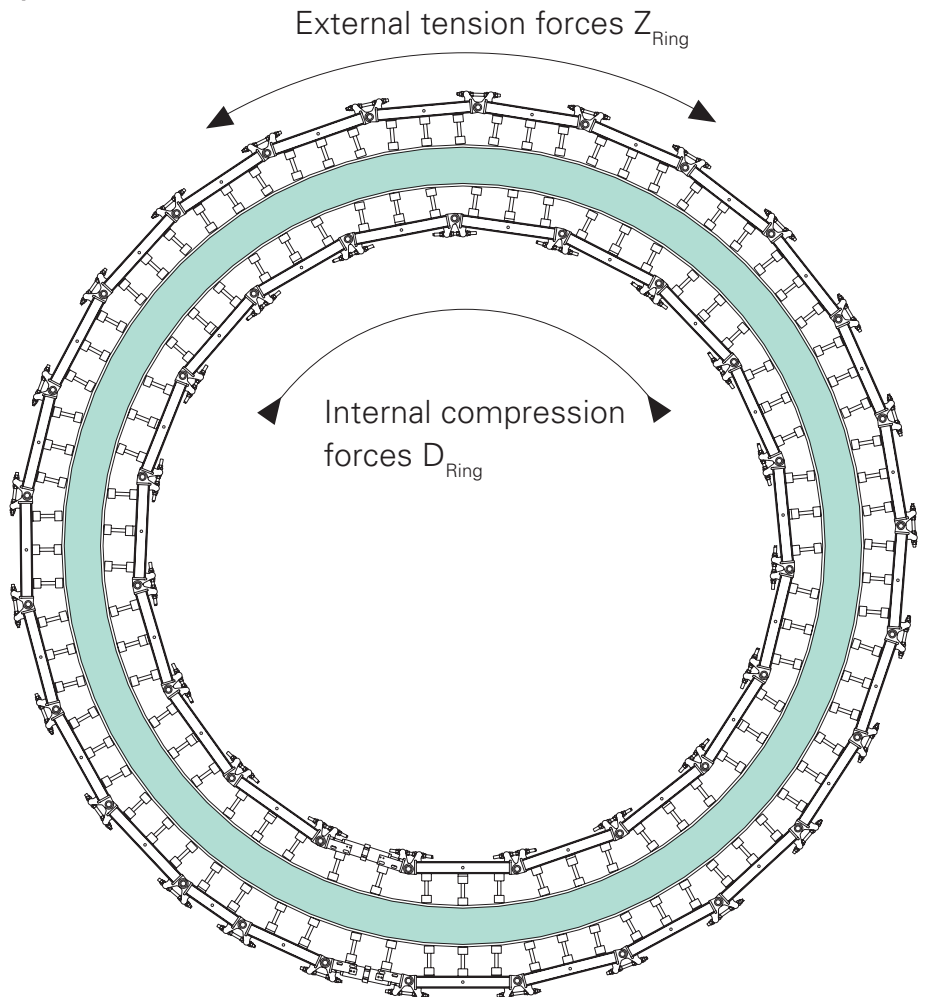

GRV Circular Formwork



Item no. Weight kg

021140	17.600
021130	23.900
021120	27.100
021110	30.200

Articulated Walers GRV
Articulated Waler GRV 30
Articulated Waler GRV 60
Articulated Waler GRV 75
Articulated Waler GRV 90

For tie-less forming of circular structures with closed formwork ring. Continuously adjustable to suit all radii.

L	X
380	300
680	600
830	750
980	900

Technical Data

Permissible compressive and tension force 300 kN.

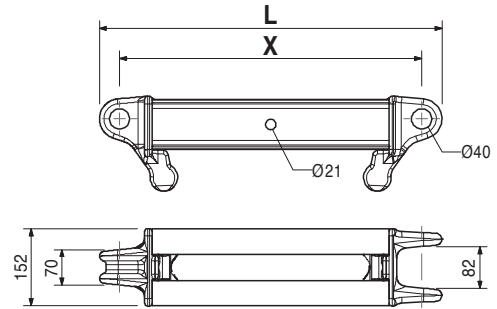
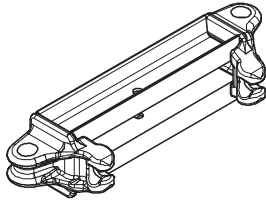

021150 49.200

Articulated Spindle Waler GSRV 65 – 90

For forming circular structures without ties by means of a completely closed circular formwork construction. For compensations, adjustable from 65 to 90 cm.

Technical Data

Permissible compressive and tension force 300 kN.

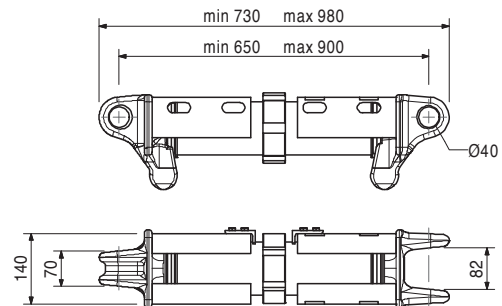
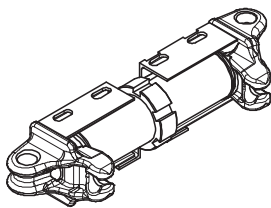

022210 1.900

Pin for GRB, galv.

For connecting the Articulated Waler GRV and Articulated Adjustable Waler GSRV 65 – 90.

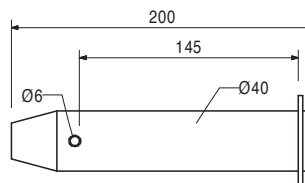
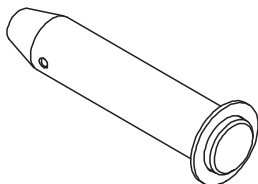

022230 0.033

Accessories

Cotter Pin 5/1, galv.

Item no.	Weight kg
022230	0.033

Cotter Pin 5/1, galv.

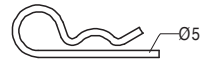

021160	2.450
--------	-------

Hook Spanner HKS for GRV

For adjusting the Articulated Adjustable Waler GSRV 65 – 90.

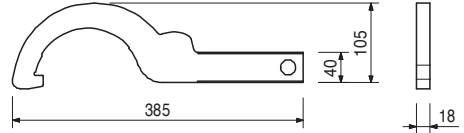
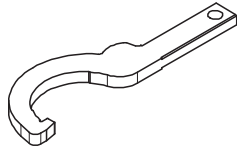

021240	0.907
021250	1.260

Adjusting Bolts STS

Adjusting Bolt STS 260, galv.

Adjusting Bolt STS 360, galv.

For adjusting Articulated Waler GRV and Articulated Adjustable Waler GSRV 65 – 90.

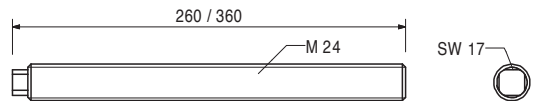
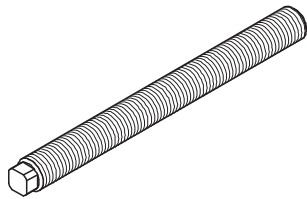

022250	0.100
021260	0.178

Accessories

Nut ISO 4032 M24-8, galv.

Half Round Washer HRS, galv.

022250	0.100
--------	-------

Nut ISO 4032 M24-8, galv.

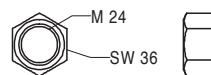

021260	0.178
--------	-------

Half Round Washer HRS, galv.

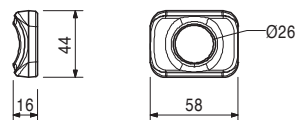

Item no.	Weight kg
021270	15.000

GRV Bearing Block, left

For using the Articulated Waler GRV for special applications.

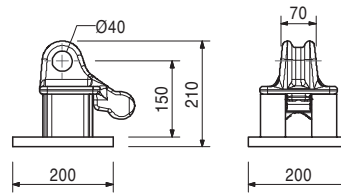
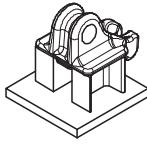

021280	15.100
--------	--------

GRV Bearing Block, right

For using the Articulated Waler GRV for special applications.

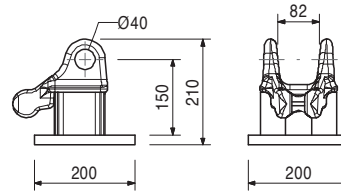
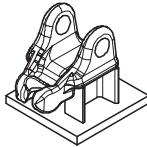

021290	4.880
--------	-------

GRV Spindle Connector

For using the Articulated Waler GRV for special applications.

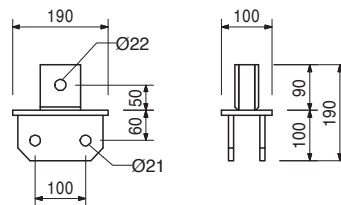
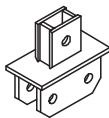

Item no.	Weight kg
024480	7.040

Extension Splice 24-2

For extending GT 24 girders and VARIO GT 24 panels up to max. height of 8.00 m.

Complete with

2 pc. 030190 Three Wingnut DW 15, galv.

Note

Permissible load: see PERI Design Tables.

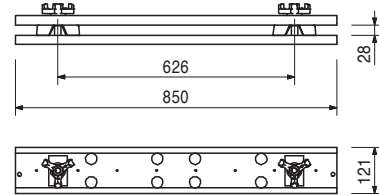

070760	4.650
--------	-------

Crane Splice GT 24

For transporting elements by crane with the GT 24 girder.

Complete with

1 pc. 018050 Pin \varnothing 16 x 65/86, galv.

2 pc. 018060 Cotter Pin 4/1, galv.

Note

Follow Instructions for Use!

Technical Data

Permissible load-bearing capacity 700 kg with crane sling angle $\leq 15^\circ$.

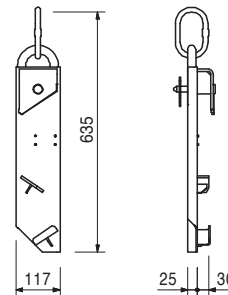
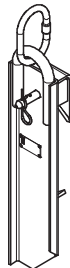

021990	2.780
021980	2.780

Crane Eyes 24

Crane Eye 24, right

Crane Eye 24, left

For transporting elements by crane with the GT 24 girder. Mounted securely to the element.

Complete with

4 pc. 710138 Bolt ISO 4014 M10 x 110-8.8, galv.

4 pc. 780356 Nut ISO 7042 M10-8, galv.

4 pc. 710139 Washer R11 DIN 440, galv.

Note

Illustration shows Crane Eye 24, left.

Follow Instructions for Use!

Technical Data

Permissible load-bearing capacity 700 kg with crane sling angle $\leq 15^\circ$.

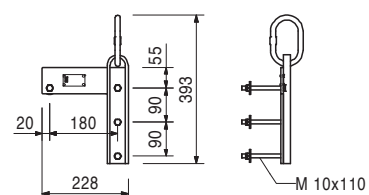
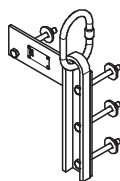

Item no.	Weight kg
027110	11.000

Scaffold Bracket GB 80

For assembly of a working and concreting scaffold with GT 24 girder.

Technical Data

Permissible load 150 kg/m². Maximum width of influence 1.25 m.

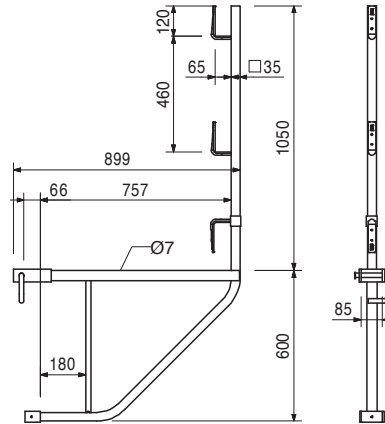
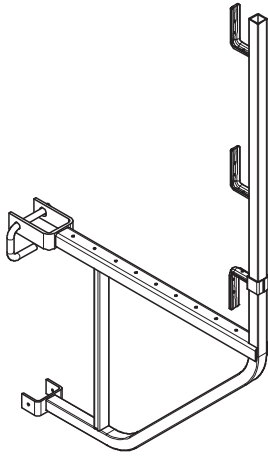

112159	2.120
--------	-------

Handrail Post Holder VARIO

For assembling a guardrail with GT 24 Girder.

Complete with

- 1 pc. 024250 Wedge K, galv.
- 1 pc. 780800 Sleeve ISO 8752 8 x 20, galv.

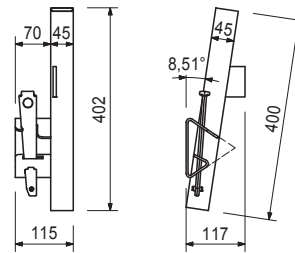
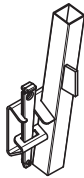

Accessories

116292	4.730
--------	-------

Guardrail Post HSGP-2

116292	4.730
--------	-------

Guardrail Post HSGP-2

As guardrail for different systems.

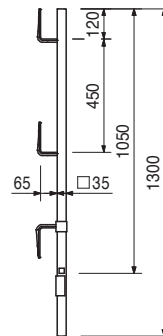

GRV Circular Formwork



Item no.	Weight kg
117466	10.600

Push-Pull Prop RS 210, galv.

Extension length $l = 1.30 - 2.10$ m.
For aligning PERI formwork systems and precast concrete elements.

Note

Permissible load see PERI Design Tables.

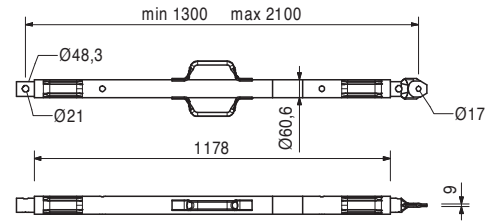
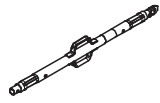

118238	12.200
--------	--------

Push-Pull Prop RS 260, galv.

Extension length $l = 2.30 - 2.60$ m.
For aligning PERI formwork systems and precast concrete elements.

Note

Permissible load see PERI Design Tables.

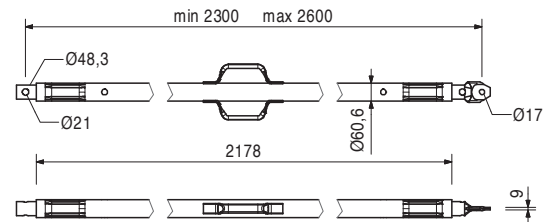
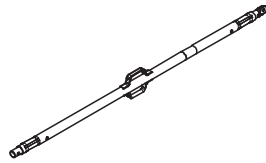

117467	15.500
--------	--------

Push-Pull Prop RS 300, galv.

Extension length $l = 1.90 - 3.00$ m.
For aligning PERI formwork systems and precast concrete elements.

Note

Permissible load see PERI Design Tables.

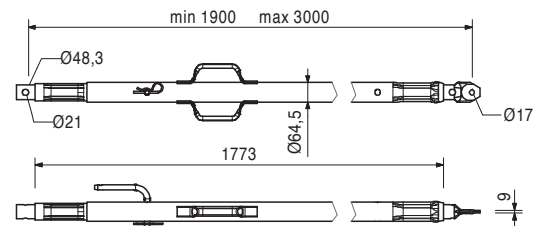
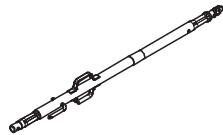

117468	23.000
--------	--------

Push-Pull Prop RS 450, galv.

Extension length $l = 2.80 - 4.50$ m.
For aligning PERI formwork systems and precast concrete elements.

Note

Permissible load see PERI Design Tables.

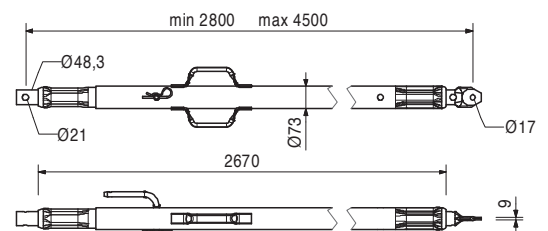
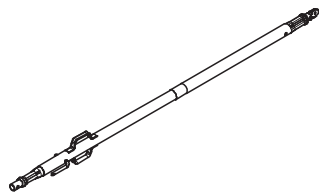

GRV Circular Formwork



Item no.	Weight kg
117469	40.000

Push-Pull Prop RS 650, galv.
 Extension length $l = 4.30 - 6.50$ m.
 For aligning PERI formwork systems and precast concrete elements.

Note
 Permissible load see PERI Design Tables.

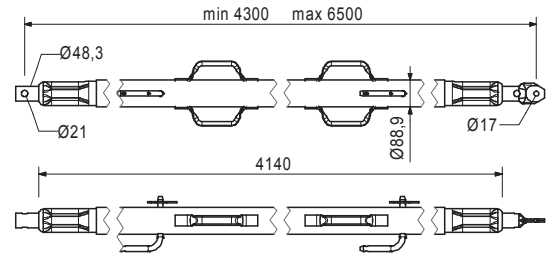
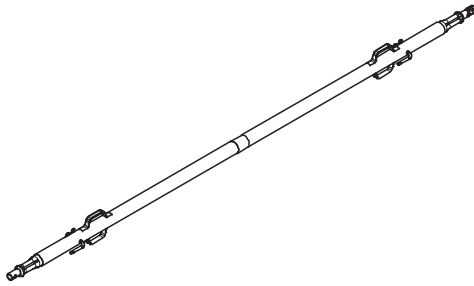

028990	115.000
--------	---------

Push-Pull Prop RS 1000, galv.
 Extension length $l = 6.40 - 10.00$ m.
 For aligning PERI formwork systems.

Note
 Permissible load see PERI Design Tables.

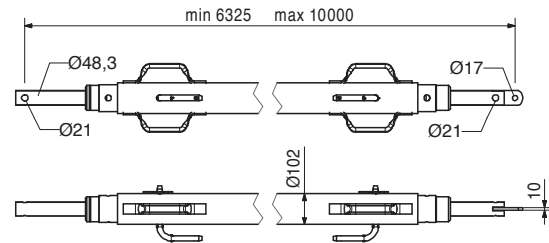
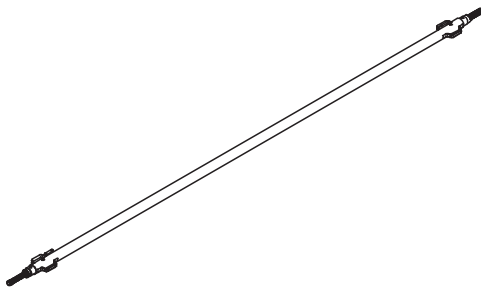

103800	271.000
--------	---------

Push-Pull Prop RS 1400, galv.
 Extension length $l = 6.40 - 14.00$ m.
 For aligning PERI formwork systems.

Note
 Permissible load see PERI Design Tables.
 Chain can be operated from bottom.

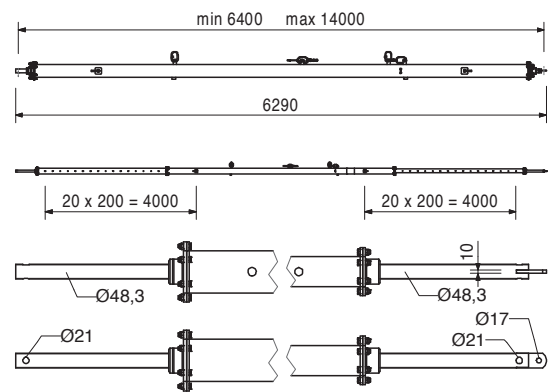
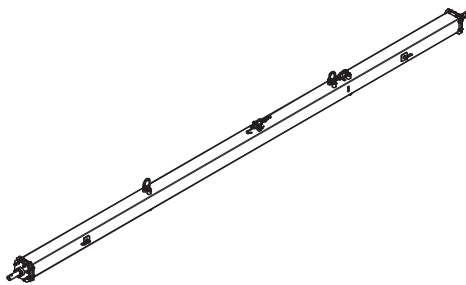

Item no.	Weight kg
117343	3.250

Base Plate-2 for RS 210 – 1400, galv.
 For assembly of Push-Pull Props RS 210, 260, 300, 450, 650, 1000 and 1400.

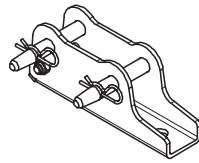

Complete with
 2 pc. 105400 Pin Ø 20 x 140, galv.
 2 pc. 018060 Cotter Pin 4/1, galv.

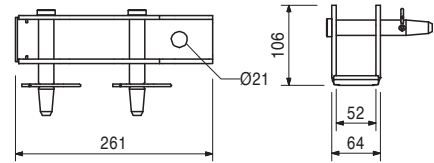

Accessories

124777	0.210
--------	-------

Anchor Bolt PERI 14/20 x 130

126666	3.070
--------	-------

Base Plate-3 for RS 210 - 1400
 For assembly of Push-Pull Props RS 210, 260, 300, 450, 650, 1000 and 1400.

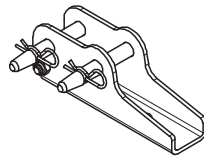

Complete with
 2 pc. 105400 Pin Ø 20 x 140, galv.
 2 pc. 018060 Cotter Pin 4/1, galv.
 1 pc. 113063 Bolt ISO 4014 M12 x 80-8.8, galv.
 1 pc. 113064 Hex Nut ISO7042-M12-8-G, galv.

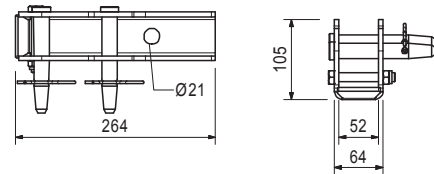

Accessories

124777	0.210
--------	-------

Anchor Bolt PERI 14/20 x 130

028010	17.900
--------	--------

Push-Pull Prop RSS I
 Extension length $l = 2.05 - 2.94$ m.
 For aligning PERI formwork systems.

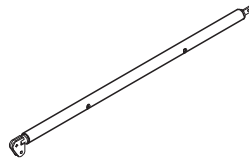

Note
 Permissible load see PERI Design Tables.

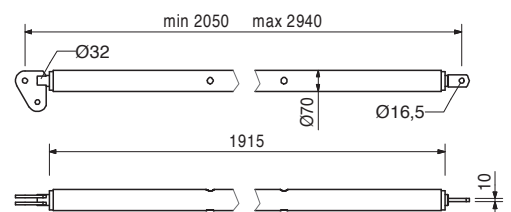

113397	1.600
--------	-------

Spindle Handle RSS / AV
 Spindle Handle for screwing on Push-Pull-Props RSS I, RSS II, RSS III and Kickers AV 210 and AV 190 complete with 2 bolts and nuts M8.

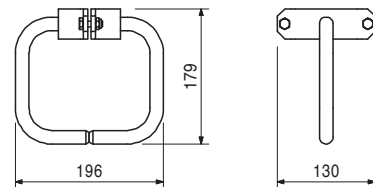
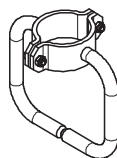

Item no.	Weight kg
028020	22.000

Push-Pull Prop RSS II

Extension length $l = 2.91 - 3.80$ m.
For aligning PERI formwork systems.

Note

Permissible load see PERI Design Tables.

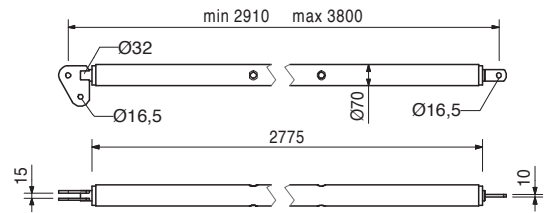
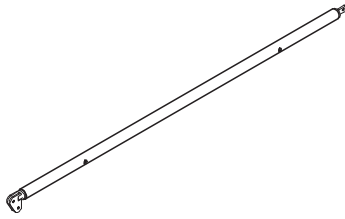

028030	38.400
--------	--------

Push-Pull Prop RSS III

Extension length $l = 4.60 - 6.00$ m.
For aligning PERI formwork systems.

Note

Permissible load see PERI Design Tables.

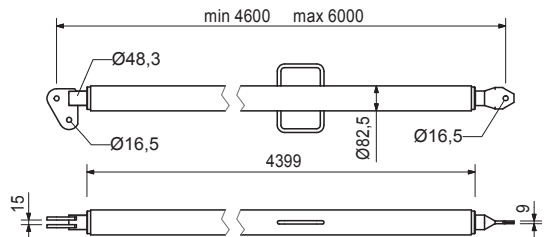
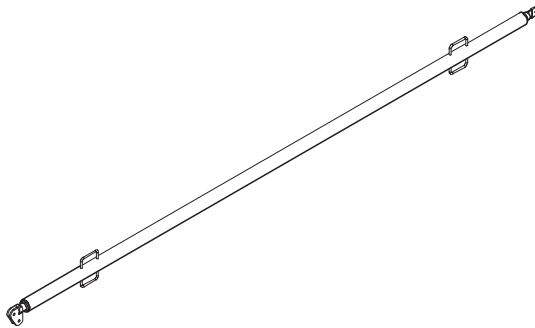

106000	1.820
--------	-------

Base Plate-2 for RSS, galv.

For assembly of RSS Push-Pull Props.

Complete with

- 1 pc. 027170 Pin $\varnothing 16 \times 42$, galv.
- 1 pc. 018060 Cotter Pin 4/1, galv.

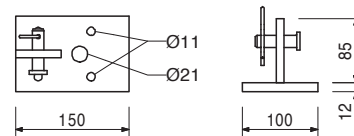
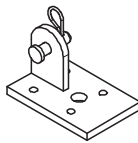

Accessories

124777	0.210
--------	-------

Anchor Bolt PERI 14/20 x 130

Item no.	Weight kg
057087	3.720
057088	4.410

Kickers AV
Kicker AV 82
Kicker AV 111
 For aligning PERI formwork systems.

min. L	max. L
500	820
790	1110

Complete with
 1 pc. 027170 Pin Ø 16 x 42, galv.
 1 pc. 018060 Cotter Pin 4/1, galv.

Note
 Permissible load see PERI Design Tables.

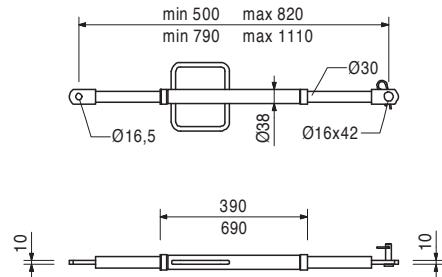
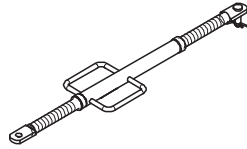

028110	5.180
--------	-------

Kicker AV 140
 Extension length l = 1.08 – 1.40 m.
 For aligning PERI formwork systems.

Complete with
 1 pc. 027170 Pin Ø 16 x 42, galv.
 1 pc. 018060 Cotter Pin 4/1, galv.

Note
 Permissible load see PERI Design Tables.

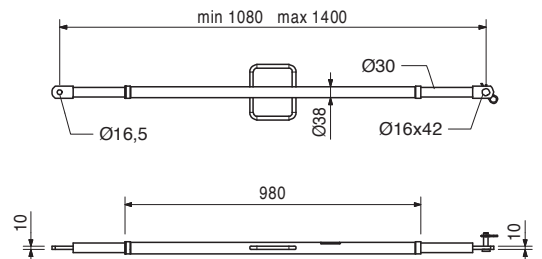
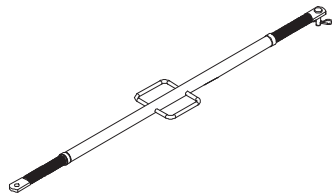

108135	12.900
--------	--------

Kicker AV 210
 Extension length l = 1.28 – 2.10 m.
 For aligning PERI formwork systems.

Complete with
 1 pc. 027170 Pin Ø 16 x 42, galv.
 1 pc. 018060 Cotter Pin 4/1, galv.

Note
 Permissible load see PERI Design Tables.

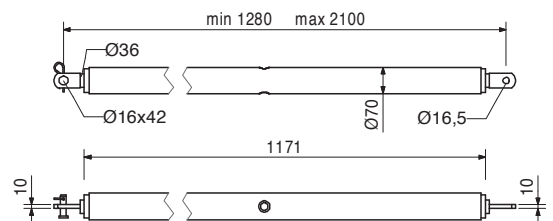
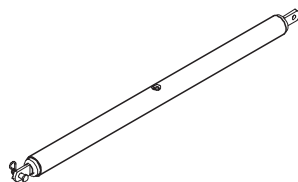

Item no.	Weight kg
028120	17.000

Kicker AV RSS III

Extension length $l = 2.03 - 2.92$ m.
For aligning PERI formwork systems.

Complete with

1 pc. 027170 Pin $\varnothing 16 \times 42$, galv.
1 pc. 018060 Cotter Pin 4/1, galv.

Note

Permissible load see PERI Design Tables.

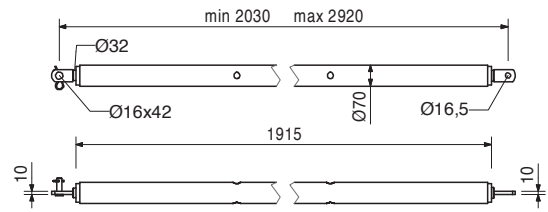
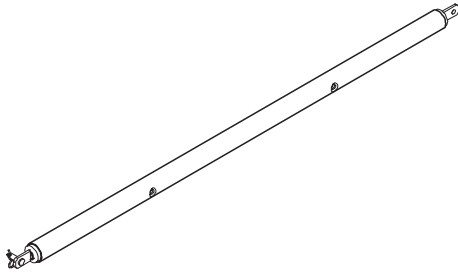

124777	0.210
--------	-------

Anchor Bolt PERI 14/20 x 130

For temporary fixation to reinforced concrete structures.

Note

See PERI data sheet!
Drilling $\varnothing 14$ mm.

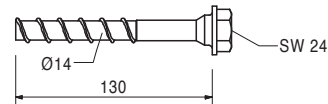
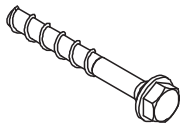



01 Germany
PERI GmbH
 Rudolf-Diesel-Strasse 19
 89264 Weissenhorn
 info@peri.com
 www.peri.com



02 France
 PERI S.A.S.
 77109 Meaux Cedex
 peri.sas@peri.fr
 www.peri.fr

03 Switzerland
 PERI AG
 8472 Ohringen
 info@peri.ch
 www.peri.ch

04 Spain
 PERI S.A.U.
 28110 Algete - Madrid
 info@peri.es
 www.peri.es

05 Belgium/Luxembourg
 N.V. PERI S.A.
 1840 Londerzeel
 info@peri.be
 www.peri.be

06 Netherlands
 PERI Holding B.V.
 5480 AH-Schijndel
 info@peri.nl
 www.peri.nl

07 USA
 PERI Formwork Systems, Inc.
 Elkridge, MD 21075
 info@peri-usa.com
 www.peri-usa.com

08 Indonesia
 PT Beton Perkasa Wijaksana
 Jakarta 10210
 bpw@betonperkasa.com
 www.peri.com

09 Italy
 PERI S.p.A.
 20060 Basiano
 info@peri.it
 www.peri.it

10 Japan
 PERI Japan K.K.
 Tokyo 103-0015
 info@perijapan.jp
 www.perijapan.jp

11 United Kingdom/Ireland
 PERI Ltd.
 Rugby, CV23 0AN
 info@peri.ltd.uk
 www.peri.ltd.uk

12 Turkey
 PERI Kalip ve Iskeleleri Sanayi
 ve Ticaret Ltd.
 Esenyurt / Istanbul 34510
 info@peri.com.tr
 www.peri.com.tr

13 Hungary
 PERI Kft.
 1181 Budapest
 info@peri.hu
 www.peri.hu

14 Malaysia
 PERI Formwork Malaysia Sdn. Bhd.
 43300 Seri Kembangan,
 Selangor Darul Ehsan
 info@perimalaysia.com
 www.perimalaysia.com

15 Singapore
 PERI Asia Pte Ltd
 Singapore 387355
 pha@periasia.com
 www.periasia.com

16 Austria
 PERI Ges.mbh
 3134 Nußdorf ob der Traisen
 office@peri.at
 www.peri.at

17 Czech Republic
 PERI spol. S r.o.
 252 42 Jesenice u Prahy
 info@peri.cz
 www.peri.cz

18 Denmark
 PERI Danmark A/S
 2670 Greve
 peri@peri.dk
 www.peri.dk

19 Finland
 PERI Formas Ltd. Oy
 05460 Hyvinkää
 info@perisuomi.fi
 www.perisuomi.fi

20 Norway
 PERI Norge AS
 3036 Drammen
 info@peri.no
 www.peri.no

21 Poland
 PERI Polska Sp. z o.o.
 05-860 Plochocin
 info@peri.com.pl
 www.peri.com.pl

22 Sweden
 PERI Sverige AB
 30262 Halmstad
 peri@periform.se
 www.periform.se

23 Korea
 PERI (Korea) Ltd.
 Seoul 06243
 info@perikorea.com
 www.perikorea.com

24 Portugal
 Pericofragens Lda.
 2790-326 Queijas
 info@peri.pt
 www.peri.pt

25 Argentina
 PERI S.A.
 B1625GPA Escobar – Bs. As.
 info@peri.com.ar
 www.peri.com.ar

26 Brazil
 PERI Formas e
 Escoramentos Ltda.
 Vargem Grande Paulista – SP
 info@peribrasil.com.br
 www.peribrasil.com.br

27 Chile
 PERI Chile Ltda.
 Colina, Santiago de Chile
 perichile@peri.cl
 www.peri.cl

28 Romania
 PERI România SRL
 077015 Balotești
 info@peri.ro
 www.peri.ro

29 Slovenia
 PERI Agency
 2000 Maribor
 peri.slo@triera.net
 www.peri.com

30 Slovakia
 PERI spol. s. r.o.
 903 01 Senec
 info@peri.sk
 www.peri.sk

31 Australia
 PERI Australia Pty. Ltd.
 Glendenning NSW 2761
 info@periaus.com.au
 www.periaus.com.au

32 Estonia
 PERI AS
 76406 Saku vald
 Harjumaa
 peri@peri.ee
 www.peri.ee

33 Greece
 PERI Hellas Solely Owned Ltd.
 194 00 Koropi
 info@perihellas.gr
 www.perihellas.gr

34 Latvia
 PERI SIA
 2118 Salaspils novads, Rigas rajons
 info@peri-latvija.lv
 www.peri-latvija.lv

35 United Arab Emirates
 PERI (L.L.C.)
 Dubai U.A.E.
 perillc@perime.com
 www.perime.com

36 Canada
 PERI Formwork Systems, Inc.
 Bolton, ON – L7E 1K1
 info@peri.ca
 www.peri.ca



37 Lebanon
PERI Lebanon Sarl
90416 – Jdeideh
lebanon@peri.de

44 Russian Federation
OOO PERI
142407, Noginsk District
moscow@peri.ru
www.peri.ru

51 Turkmenistan
PERI Kalıp ve İskeleleri
Aşgabat
ahmet.kadioglu@peri.com.tr
www.peri.com.tr

57 Saudi Arabia
PERI Saudi Arabia Ltd.
21463 Jeddah
info@peri.com.sa
www.peri.com.sa

64 Nigeria
PERI Nigeria Ltd.
Lagos
info@peri.ng
www.peri.ng

38 Lithuania
PERI UAB
02300 Vilnius
info@peri.lt
www.peri.lt

45 South Africa
PERI (Pty) Ltd
7600 Stellenbosch
info@peri.co.za
www.peri.co.za

52 Belorussia
IOOO PERI Belarus
220100 Minsk
info@peri.by
www.peri.by

58 Qatar
PERI Qatar LLC
P.O.Box: 31295 - Doha
info@periqatar.com
www.peri.qa

65 Oman
PERI (L.L.C.)
Muscat
perimct@perime.com
www.perime.com

39 Morocco
PERI S.A.U.
Tanger
info@peri.ma
www.peri.ma

46 Ukraine
TOW PERI
07400 Brovary
peri@peri.ua
www.peri.ua

53 Croatia
PERI oplate i skele d.o.o.
10 250 Lučko-Zagreb
info@peri.com.hr
www.peri.com.hr

59 Algeria
Sarl PERI
Kouba 16092, Alger
info@peri.com
www.peri.com

66 Colombia
PERI S.A.S. Colombia
Briceño, Cundinamarca
peri.colombia@peri.com.co
www.peri.com.co

40 Israel
PERI Formwork
Engineering Ltd.
Rosh Ha'ayin, 48104
info@peri.co.il
www.peri.co.il

47 Egypt
PERI Branch Office
11341 Nasr City /Cairo
info@peri.com.eg
www.peri.com.eg

54 India
PERI (India) Pvt Ltd
Mumbai – 400064
info@peri.in
www.peri.in

60 Albania
PERI Representative Office
Tirane
info@peri.com.tr
www.peri.com.tr

67 Philippines
PERI-Asia Philippines, INC.
Makati City
info@peri.com.ph
www.peri.com.ph

41 Bulgaria
PERI Bulgaria EOOD
1839 Sofia
peri.bulgaria@peri.bg
www.peri.bg

48 Serbia
PERI – Oplate d.o.o.
22310 Šimanovci
office@peri.rs
www.peri.rs

55 Jordan
PERI GmbH - Jordan
11947 Amman
jordan@peri.com
www.peri.com

61 Peru
PERI Peruana S.A.C.
Villa El Salvador, Lima
contacto@peri.com.pe
www.peri.com.pe

68 Hong Kong
PERI (Hong Kong) Limited
Hong Kong SAR, PRC
bob.dover@periasia.com
www.perihk.com

42 Iceland
Armar ehf.
220 Hafnarfjörður
armar@armar.is
www.armar.is

49 Mexico
PERI Cimbras y Andamios,
S.A. de C.V.
Estado de México, Huehuetoca
info@peri.com.mx
www.peri.com.mx

56 Kuwait
PERI Kuwait W.L.L.
13011 Kuwait
info@peri.com.kw
www.peri.com.kw

62 Panama
PERI Panama Inc.
0832-00155 Panama City
info@peri.com.pa
www.peri.com.pa

69 Namibia
PERI (Pty.) Ltd.
Windhoek
windhoek@peri.na
www.peri.na

43 Kazakhstan
TOO PERI Kazakhstan
050000 Almaty
peri@peri.kz
www.peri.kz

50 Azerbaijan
PERI Representative Office
Baku
peribaku@peri.com.tr
www.peri.com.tr

63 Angola
Pericofragens, Lda.
Luanda
renato.portugal@peri.pt
www.peri.pt

70 Mozambique
PERI (Pty.) Ltd.
Matola
maputo@peri.co.mz
www.peri.co.mz

**The optimal System
for every Project and
every Requirement**



Wall Formwork



Column Formwork



Slab Formwork



Climbing Systems



Bridge Formwork



Tunnel Formwork



Shoring Systems



Construction Scaffold



Facade Scaffold



Industrial Scaffold



Access



Protection Scaffold



Safety Systems



System-Independent Accessories



Services



PERI GmbH
Formwork Scaffolding Engineering
 Rudolf-Diesel-Strasse 19
 89264 Weissenhorn
 Germany
 Tel. +49 (0) 7309.950-0
 Fax +49 (0) 7309.951-0
 info@peri.com
 www.peri.com